

REVISIONS			
REV.	DESCRIPTION	DATE	APPROVED
A	RELEASE TO PRODUCTION	11/03/2000	JAG
B	REVISE SCREWS	01/18/2007	JAG

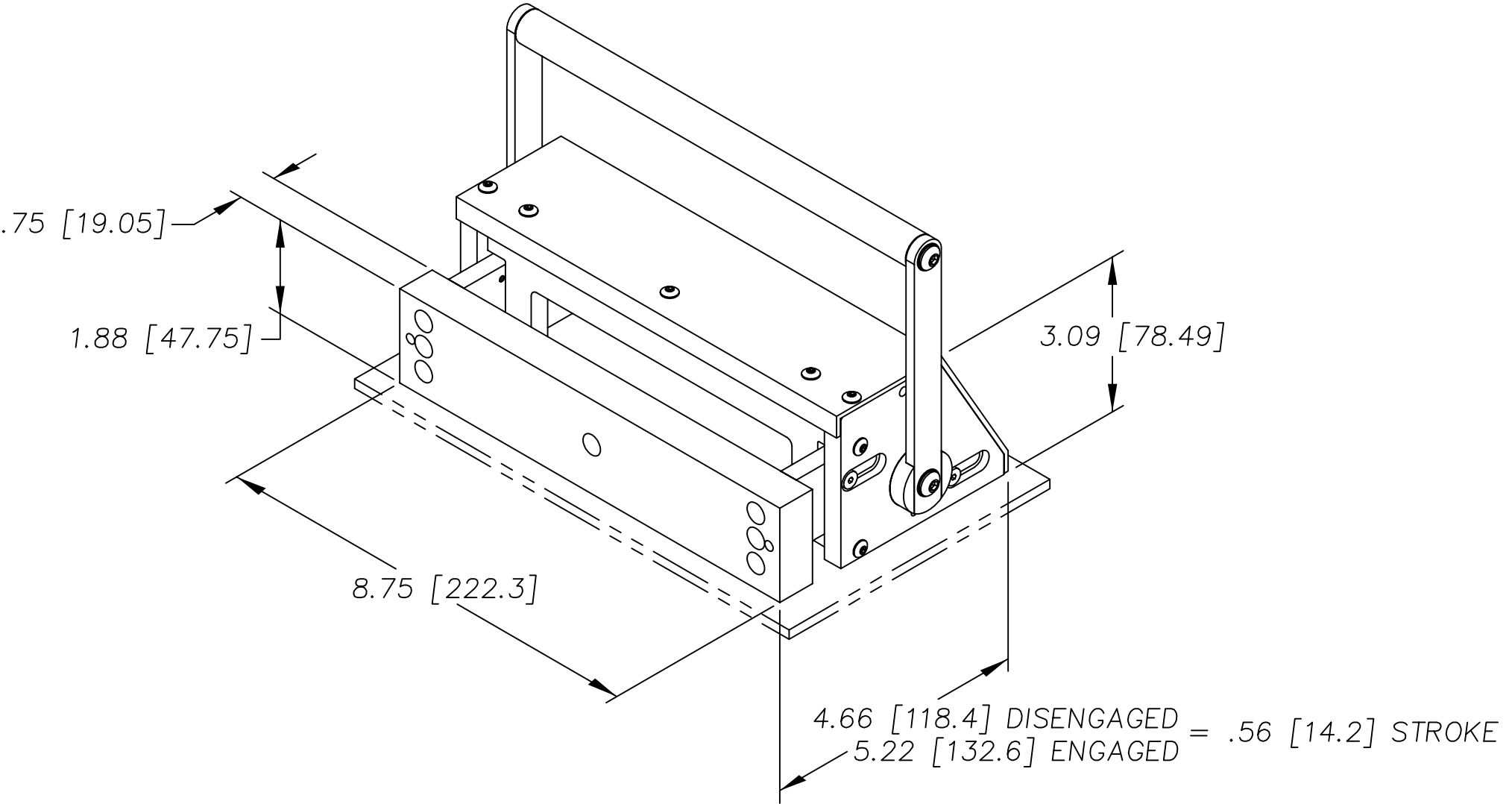

FILE NO.
FC50107BISO

		UNLESS OTHERWISE SPECIFIED DIMENSIONS ARE IN INCHES (MM) TOLERANCES ARE: .XX .XXX ANGLES ±.015 ±.005 ±1/2		H+W TEST PRODUCTS SEEKONK, MASSACHUSETTS	
		MATERIAL SEE BOM			
NEXT ASSY		USED ON		ASSEMBLY 7" SIDE ACCESS UNIT	
APPLICATION		FINISH NONE		SIZE C	FSCM NO.
		DO NOT SCALE DRAWING		DWG. NO. FC50107	REV. B
				SCALE FULL	DRAWN JAG 11/03/2000 SHEET 1 OF 1